

# MPPT Solar Charge Controller

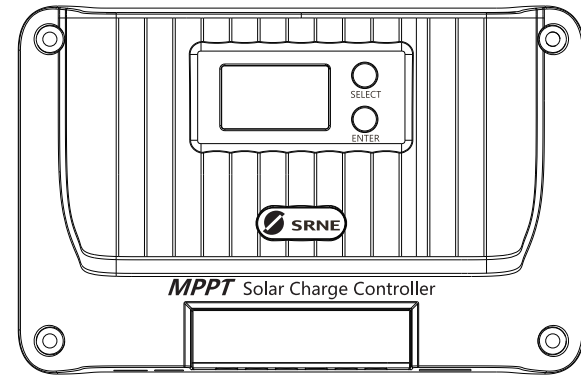









## User Manual



Dear users:

Thank you for choosing our products!

### Safety Instructions

-  1. Since the applicable voltage of the controller exceeds the safety limit of human body, please read the manual carefully before operation and operate this controller after the safety operation training is completed.
  -  2. Since no part is required to be maintained or repaired inside the controller, please do not disassemble and repair the controller by yourself.
  -  3. Please install the controller indoors to avoid exposure of components and keep water away from the controller.
  -  4. Since the cooling fin will be very hot during operation, please install the controller in a well-ventilated place.
  -  5. Suitable fuse or circuit breaker is recommended to be equipped outside the controller.
  -  6. Before installing and adjusting the wiring of the controller, make sure to disconnect the wiring of the photovoltaic array and the fuse or circuit breaker near the accumulator battery terminals.
  -  7. After installation, check whether all wiring is tightly connected to avoid the danger of heat accumulation due to loose connection.
-  **Warning:** Indicates that this operation is dangerous and safety preparations must be made before operation.
-  **Attention:** Indicates destructive operation.
-  **Tips:** Indicates suggestions and tips to the operator.

## Contents

<b>1. Product introduction</b>	03
1.1 Product overview	03
1.2 Product features	04
1.3 Description on appearance and interface	04
<b>2. Introduction to maximum power tracking technology</b>	04
<b>3. Technical parameters</b>	06
<b>4. Charging</b>	07
4.1 Charging of lead-acid battery	07
4.2 Charging of lithium battery	07
<b>5. Battery Temperature Sampling and Control</b>	08
<b>6. Load output</b>	08
<b>7. Menu</b>	09
7.1 View menu	09
<b>8. Parameter setting</b>	10
8.1 Battery parameter list	10
8.2 Parameter setting list	11
8.3 Type of battery	12
8.4. Equalizing charging\boost charging\floating charging\charging reconnect voltage\over-discharge reconnect voltage\over-discharge voltage	12
8.5 System voltage	12
8.6 Charge current	12
8.7 Full-charging setting	13
8.8 Constant voltage output of lead acid battery	13
8.9 Light control voltage	13
8.10 Light control delay	13
8.11 Load mode	13
8.12 Load short-circuit protection switch	14
8.13 Over-discharge delay	14
8.14 Temperature unit	14
8.15 RS485 communication baud rate	15
8.16 Equipment address	15
8.17 System restart	15
8.18 Factory reset	15
8.19 Historical data cleaning	15
<b>9. TTL communication</b>	16
<b>10. RS485</b>	16
<b>11. CAN communication(Optional)</b>	16
<b>12. Key</b>	16
<b>13. System alarms</b>	17
<b>14. Common problems and solutions</b>	18
<b>15. Installation</b>	18
15.1 Installation precautions	18
15.2 Installation steps	19
<b>16. Protection</b>	20
<b>17. System maintenance</b>	20
<b>18. Product dimensions</b>	21
<b>19. System connection diagram</b>	24
19.1 System wiring diagram	24

## 1. Product introduction

### 1.1 Product overview

The Shiner series controller adopts the industry-leading MPPT to achieve the maximum energy tracking for the solar panel, that is, it can quickly and accurately track the maximum power point of the solar battery on any condition, and obtain the maximum energy of the solar panel in real time, significantly improving the energy utilization rate of the solar system. It is widely used as the core control component in the off-grid PV systems to manage the work of solar panels, batteries, and loads. Besides, it has complete software and hardware fault detection and protection functions to avoid damage to product components caused by installation errors and system faults to the greatest extent.

### 1.2 Product features

- ◆ Adopt MPPT with tracking efficiency up to 99.9%.
- ◆ Support full-power charging and discharging at one time.
- ◆ Support multiple battery types such as sealed battery, gel battery, flooded battery, lithium battery and user-defined battery.
- ◆ Support lithium battery and lead-acid activated battery.
- ◆ Support the charging current setting.
- ◆ Support full-charging setting.
- ◆ Support temperature compensation.
- ◆ Support 17 load operating modes.
- ◆ Support capacitive loads and inductive loads.
- ◆ Save historical data for 200 consecutive days.
- ◆ Support RS485 communication of standard Modbus protocol with adjustable baud rate.
- ◆ Support TTL communication of standard Modbus protocol with fixed baud rate.
- ◆ Support Bluetooth communication (optional).
- ◆ Support CAN communication (optional).
- ◆ Possess complete charging and discharging protection mechanisms for overvoltage, overcurrent, overload, over-temperature, short circuit, etc.
- ◆ Adopt high-quality aluminum radiator and high-temperature derating treatment to ensure reliable and efficient operation in various operating conditions.

### 1.3 Appearance and interface description

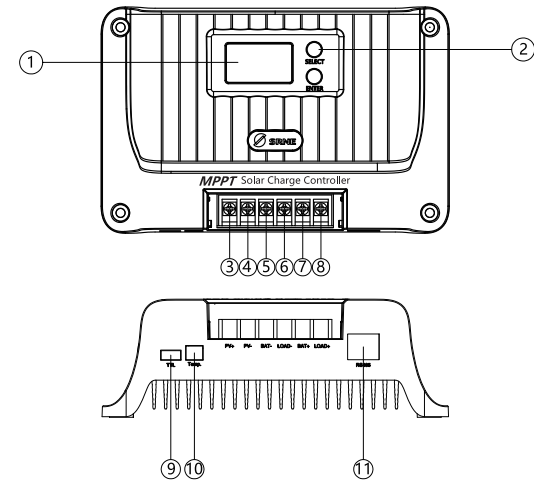

S/N	Name	S/N	Name
①	LCD	⑦	Battery positive interface
②	Button	⑧	Load positive interface
③	Solar panel positive interface	⑨	TTL communication interface
④	Solar panel negative interface	⑩	Temperature sensor interface
⑤	Battery negative interface	⑪	RS485/CAN communication interface
⑥	Load negative interface		

## 2. Introduction of Maximum Power Point Tracking

The Maximum PowerPoint Tracking (MPPT) system is an advanced charging technology with more energy output from the solar batteries by adjusting the operating state of the electrical modules. Due to nonlinearity of the solar battery array, there is a maximum power point on its curve. The PWM charging technology used in the traditional controller cannot charge the battery continuously at the point, so it cannot obtain the maximum energy of the solar panel. Instead, the solar controller with MPPT can always track the maximum power point of the array, so as to charge the battery with maximum energy. For example, for the 12V solar system, since the peak-to-peak voltage ( $V_{pp}$ ) of the solar battery is about 17V, but the battery voltage is about 12V, therefore, when the common charge controller is charging the battery, the voltage of the solar battery is about 12V, that is, the solar battery does not fully exert its maximum power.

The MPPT controller can overcome the problem and adjust the input voltage and current of the solar panel in real time to reach the maximum input power. Moreover, compared with the traditional PWM controller, it can exert the maximum power of the solar battery to provide a larger charging current. Generally speaking, it can improve the energy utilization rate by 15%~20% than the PWM controller.

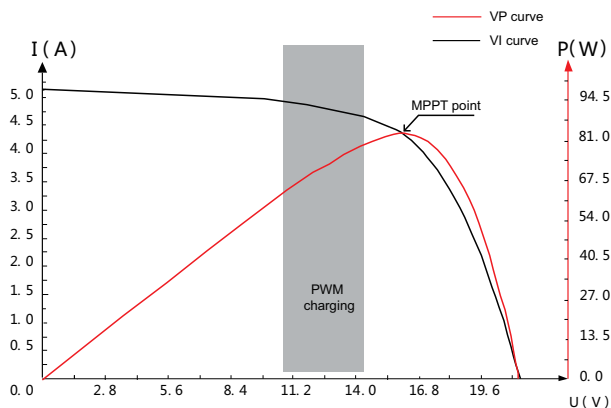

Fig. 2-1 Battery panel output characteristic curve

The maximum power point often changes due to the different ambient temperature and lighting conditions. And the MPPT controller is able to adjust the parameters in real-time under different conditions, thus making the system status always near the maximum operating point. The whole process is completely automatic without any adjustment.

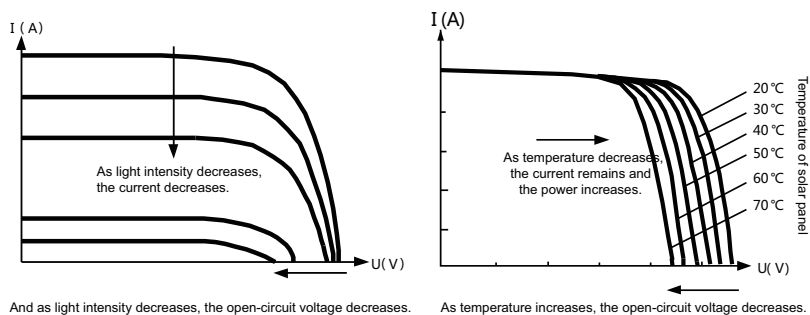

Fig. 2-2 Relationship between output characteristic of battery panel and light intensity

Fig. 2-3 Relationship between output characteristic of battery panel and temperature

### 3. Technical parameters

Product model	Shiner2410	Shiner2420	Shiner2430	Shiner2440	Shiner2460	Shiner4820
Static power consumption	≤10mA					≤20mA
Battery Type	SLD/GEL/FLD/LI/USE/USELI, SLD as default					
System voltage	12V/24V					12V/24V/36V/48V
Battery operating voltage range	8V-32V					8V-64V
Rated charging current	10A	20A	30A	40A	60A	20A
Maximum solar panel power	130W/12V 260W/24V	260W/12V 520W/24V	400W/12V 800W/24V	520W/12V 1040W/24V	800W/12V 1600W/24V	260W/12V 520W/24V 780W/36V 1040W/48V
Maximum PV open-circuit voltage	60V (55V protection, 50V recovery)		100V (95V protection, 90V recovery)			
MPPT operating voltage range	(Battery voltage +2V)~45V		(Battery voltage +2V)~72V			
MPPT tracking efficiency	>99%					
Charging conversion efficiency	85%-98% (10%-100% of rated power)					
Rated load current	10A		20A			
Load operating mode	Light control, light control + time control, manual mode (default), debugging mode, normally open					
Charging current setting	√					
Full-charging setting	√					
Constant voltage output setting	√					
Charging temperature compensation of lead-acid battery	√					
Temperature unit setting	√					
Overload/Short-circuit protection	√					
TTL communication	Baud rate: 9,600 bps					
RS485 communication	RJ45 interface, with power output 5V/200 mA, The baud rate is 9,600 bps by default, adjustable.					
Bluetooth communication	Optional					
CAN communication	RJ45 interface, optional (RV-C protocol)					
Historical data	Save the last 200 days of historical data					
Protection function	PV overvoltage protection, PV reverse connection protection, PV short-circuit protection, night reverse charging protection, input power limit protection, over-temperature protection, load short-circuit protection, overload protection, battery over-voltage/over-discharge protection, battery reverse connection protection, battery end short circuit protection.					
Grounding type	Grounding of common negative electrode					
Operating ambient temperature range	-35°C~65°C					
Protection grade	IP32					
Cooling mode	Natural heat dissipation					
Dimension	155*99*41.7mm	181*118*61.7mm	187*133*72mm	228*160*72mm	261*186*82mm	181*118*61.7mm
Weight	350g	650g	1200g	1750g	2400g	750g

## 4. Charging

### 4.1 Charging of lead-acid battery

Select such battery types as SLD/FLD/GEL/USE, and select the appropriate system voltage.

As shown in Fig. 4-1, the charging stages of lead-acid battery are: MPPT charging, constant voltage charging (equalizing/boost/floating charging), and current-limiting charging. The constant voltage charging is divided into three stages: equalizing charging, boost charging and floating charging. [MPPT charging] When the battery voltage has not reached the target constant voltage value, the controller will perform MPPT charging. When the battery voltage reaches the constant voltage value, it will automatically exit MPPT charging and switch to constant voltage charging (equalizing/boosting/floating charging).

[Equalizing charging] Regular equalizing charging is good for some batteries. Equalizing charging is mainly to make the charging voltage of battery higher than the standard supplementary voltage, besides, it can vaporize the battery electrolyte to balance the battery voltage and complete relevant chemical reaction. Equalizing charging and boosting charging are not repeated during one full charging to avoid excessive gas evolution or overheating of the battery.

Notes:

- 1) Since the equalizing charging of flooded lead-acid battery produces explosive gas, the battery compartment must be well ventilated.
- 2) Although the equalizing charging elevates the battery voltage, it may damage the level of sensitive DC loads, therefore, it is necessary to verify that the allowable input voltage of all loads in the system is greater than the set battery voltage value in equalizing charging.
- 3) Excessive charging and excessive gas evolution may damage the battery plate and cause the active substances on the battery plate to fall off. Besides, excessive high equalizing charging voltage or excessive long equalizing charging duration may damage the battery. Please set relevant parameters according to the specifications of the battery used in the system.

[Boost charging] The duration of boost charging is 2 h (default). When the duration reaches the set value, the system will switch to floating charging.

[Floating charging] Floating charging is the last constant voltage charging stage in the charging cycle of lead-acid battery. The controller keeps the charging voltage constant at the floating charging voltage. At this stage, the battery is charged with a very weak current to ensure that the battery is in full-charging. When the battery voltage is as low as the reconnect voltage of boost charging, the system will exit the floating charging stage and re-enter the next charging cycle.

### 4.2 Charging of lithium battery

Select such battery types as LI/USE LI, and select the system voltage from 12V/24V.

As shown in Fig. 4-2, the charging stages of lithium battery are: MPPT charging/boost charging/ current-limiting charging.

[MPPT charging] When the battery voltage does not reach the target constant voltage value, the controller conducts MPPT charging to charge the battery with maximum solar power, when reaches, it automatically switches to boost charging.

[Boost charging] In the boost charging stage of lithium battery, when the battery voltage is lower than the boost charging voltage, the system conducts MPPT charging or current-limiting charging, when reaches, it switches to boost charging.

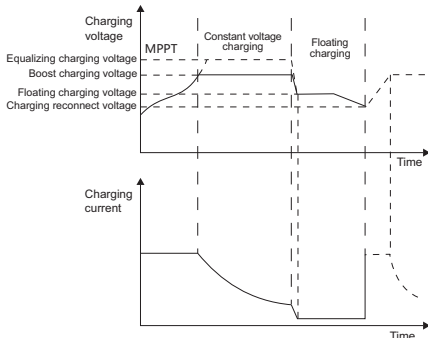

Fig. 4-1 Charging curve of lead acid battery

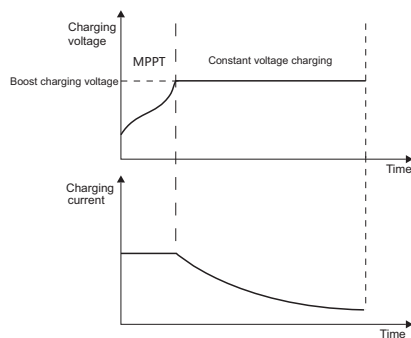
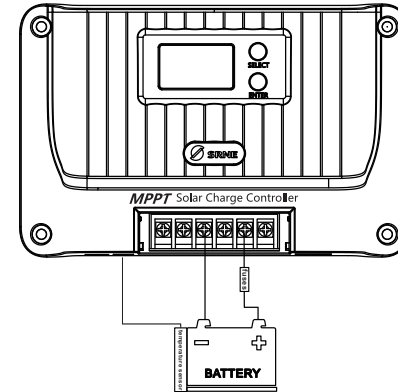

Fig. 4-2 Charging curve of lithium battery

## 5. Battery Temperature Sampling and Control

1) Connect the temperature sensor to the corresponding temperature interface to achieve the high and low temperature protection for the battery and the temperature compensation for the charging voltage of lead-acid battery (no temperature compensation for the lithium battery); if the temperature sensor is not connected, the default temperature is 25°C;

2). For the battery-related temperature protection/recovery value, please refer to the description in "12. System alarm". The wiring method is shown in the figure:



## 6. Load output

1) [Recovery strategy of load short-circuit protection]:

① Automatic recovery: the self recovery time of the first protection is 10s, the second is 15s, the third is 20s, the fourth is 25s, the fifth is 30s, with more than five times restore the load output the next day;

② Manual recovery: press and hold the "SELECT" button for 2s on the system alarm interface, and the load will be recovered and output;

2) [Overload protection strategy]: 10s protection for the load greater than 1.25 times the rated load; 5s protection for the load greater than 1.5 times the rated load; 1s protection for the load greater than 2 times the rated load;

3) Please refer to "8.11-8.13" for load related settings.

## 7. Menu

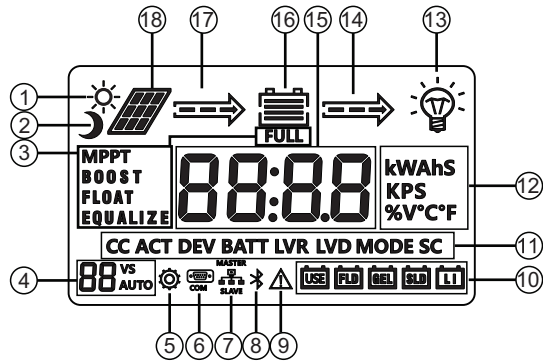

No.	Description	No.	Description
①	Daytime icon	⑩	Battery type
②	Night icon	⑪	Function character
③	Charging stage	⑫	Unit symbol
④	System voltage	⑬	Load icon
⑤	Parameter setting	⑭	Discharging state
⑥	Communication icon	⑮	Battery
⑦	Parallel communication	⑯	Voltage/current
⑧	Bluetooth icon	⑰	Charging state
⑨	System alarms	⑱	Solar panel

## 7.1 View menu

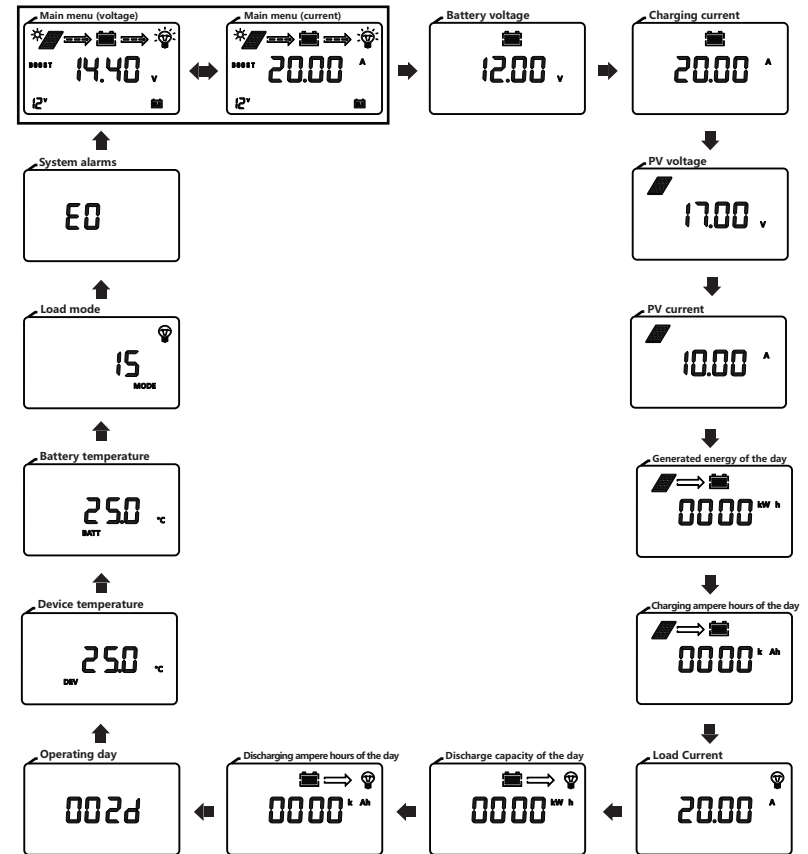

- 1) Alternative display between (voltage) and (current) on the main menu every 10s.
- 2) Short press the [SELECT] key to browse the menu. If there is no key operation for 5s, it will automatically return to the main menu.
- 3) Long press [ENTER] for 3s on any interface to enter the parameter setting page.

## 8. Parameter setting

### 8.1 Battery parameter list

Battery parameters						
Battery Type Setting/Voltage	Sealed Lead-Acid SLD	Gel lead-acid battery GEL	Flooded lead-acid battery FLD	Lithium battery LI	Custom lead acid battery USE	Custom lithium battery USE LI
Overvoltage disconnect voltage <sup>①</sup>	16.0V	16.0V	16.0V	16.0V	Boost voltage +2V	Boost voltage +2V
Equalizing voltage <sup>①</sup>	14.6V	--	14.8V	--	9~17V	--
Boost voltage <sup>①</sup>	14.4V	14.2V	14.6V	14.4V	9~17V	9~17V
Float charge voltage <sup>①</sup>	13.8V	13.8V	13.8V	--	9~17V	--
Boost charging reconnect voltage <sup>①</sup>	13.2V	13.2V	13.2V	13.2V	9~17V	9~17V
Over-discharge restoring voltage <sup>①</sup>	12.6V	12.6V	12.6V	12.6V	9~17V	9~17V
Under-voltage alarming voltage <sup>①</sup>	12.0V	12.0V	12.0V	12.0V	9~17V	9~17V
Over-discharge voltage <sup>①</sup>	11.1V	11.1V	11.1V	11.1V	9~17V	9~17V
Over-discharge cutoff voltage <sup>①</sup>	10.6V	10.6V	10.6V	10.6V	9~17V	9~17V
Over-discharge delay	5s	5s	5s	5s	5s	5s
Equalizing charging interval	30 days	--	30 days	--	30 days	--
Equalizing charging duration	120 min	--	120 min	--	120 min	--
Boost charging duration	120 min	120 min	120 min	--	120 min	--
Temperature compensation factor mV/°C/2V	-3	-3	-3	--	-3	--

Note:  
<sup>①</sup> The above values are the parameters at 25°C/12V; if it is the system of 24V/36V/48V, relevant voltage points shall be automatically multiplied by 2/3/4.

### 8.2 Parameter setting list

Function	Setting range	Default
Battery Type	SLD/GEL/FLD/LI/USE/USE LI	SLD
Equalizing charging voltage <sup>①</sup>	9V~17V	Available for USE only
Boost charging voltage <sup>①</sup>	9V~17V	Available for USE and USE LI only
Float charge voltage <sup>①</sup>	9V~17V	Available for USE only
Boost charging reconnect voltage <sup>①</sup>	9V~17V	Available for USE and USE LI only
Over-discharge restoring voltage <sup>①</sup>	9V~17V	Available for USE and USE LI only
Over-discharge voltage <sup>①</sup>	9V~17V	Available for USE and USE LI only
System voltage	12/24/AUTO	AUTO
Charging current	0-rated current (0: no charging)	Rated current
Full-charging setting	0-10 A, 0: turn the function off 0	0
Full-charging setting	on: constant voltage output in no load on the battery terminal oF: no output in no load on the battery terminal	oF
Light control voltage <sup>①</sup>	5-11V	5V
Light control delay	60-3,600s	60s
Load mode	0-17	15
Load short-circuit protection	on: open load short-circuit protection oF: close load short-circuit protection	on
Over-discharge delay	1-60s	5s
Temperature unit	°C: Celsius/°F: Fahrenheit	°C
RS485 communication baud rate	1200~115200bps	9600bps
Device address	1-247	1
System restart	F01	Function key
Factory data reset	F02	Function key
Clear historical data	F03	Function key

Note:  
<sup>①</sup> : 24V/36V/48V battery system, automatically multiply by 2/3/4 according to the set value to get the actual control value.

### 8.3 Type of battery

Please refer to "8.1 and 8.2" for setting.

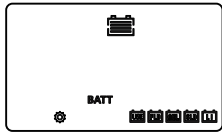

### 8.4 Equalizing charging\boost charging\floating charging\charging reconnect voltage\over-discharge reconnect voltage\over-discharge voltage

The option can only be set when the battery type is "USE" or "USE LI".

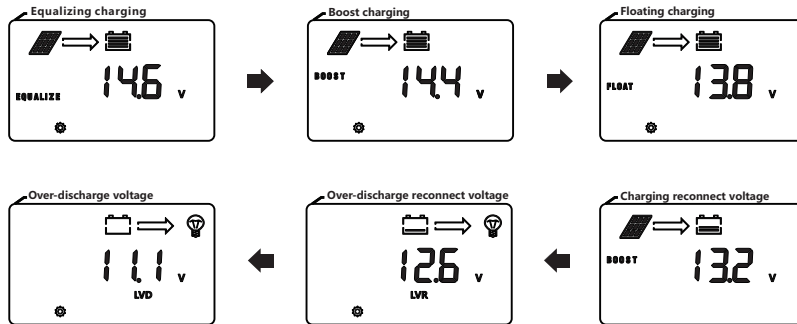

### 8.5 System voltage

When the system voltage changes, the system voltage icon on the main page will flash, prompting the user to reboot for effective operation.

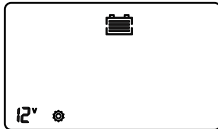

### 8.6 Charging current

- 1) [No charging]: Set 0
- 2) [Limit charging current] Set an arbitrary value from 1 to rated charging current in steps of 1A.

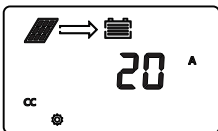

### 8.7 Full-charging setting

- 1) [Off]: Set 0
- 2) [On]: Select the appropriate current value between 1-10A

**Full-charging condition:**When the constant voltage charging duration of lithium battery reaches the set duration or the lead-acid battery is in float charging after the equalizing charging or the boost charging is finished, and the charging current is less than the set current value, the system will stop charging after 1 minute, and the "FULL" icon will light up on the screen.

**Charging recovery condition:**The battery voltage is less than the boost charging reconnect voltage, the system will recover charging, and the "FULL" icon will light off on the screen.

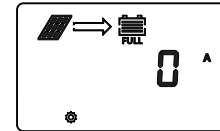

### 8.8 Constant voltage output of lead acid battery

Constant voltage output without battery

No output without battery

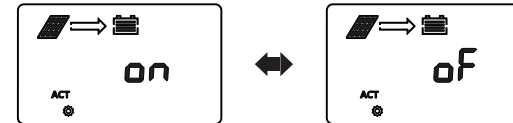

### 8.9 Light control voltage

- 1) [Light control on]: The solar panel voltage is less than  $5V \times N$
- 2) [Light control of]: The solar panel voltage is greater than  $6V \times N$   
( $N=1/2$ )



### 8.10 Light control delay

Minimum duration required to meet the light control on or off condition.



### 8.11 Load mode





LCD screen number	Load mode	Description
0	Pure light control	When the solar panel voltage is less than the Light control ON voltage with a duration is more than the light control delay, turn on the load; When the solar panel voltage is greater than the light control OFF voltage with a duration is greater than the light control delay, turn off the load.
1~14	Light control + time control 1-14 h	After the duration during which the solar panel voltage is less than the light control ON voltage is greater than the light control delay, turn on the load. After the load has been operating for the set time, turn off the load. After the duration during which the solar panel voltage is greater than the light control OFF voltage is greater than the light control delay, turn off the load (light control prevails).
15	Manual mode(default)	Short press [ENTER] key to turn on/off the load (not affected by light control)
16	Debugging mode	When the solar panel voltage is less than the light control ON voltage, turn on the load immediately When the solar panel voltage is greater than the light control OFF voltage, turn off the load immediately
17	Normal on mode	The load is always on(In case of battery over-voltage, battery over-discharge, load short-circuit, overload, battery over-temperature, or battery low-temperature, the load will turn off the output)

### 8.12 Load short-circuit protection switch

Some inductive loads or capacitive loads will produce high current at the moment of start-up, which will easily trigger load short-circuit protection, resulting in failure to turn on the load. This function can be disabled when the system cannot be started (Note: After this function is disabled, short circuit at load side of the controller is prohibited!)

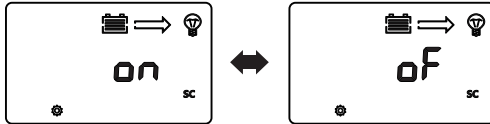

### 8.13 Over-discharge delay

After the battery voltage is lower than the over-discharge voltage, the controller turns off the delay time for the load. (Note: only the type of custom battery can be set)

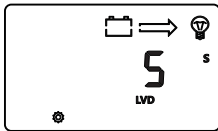

### 8.14 Temperature unit

The unit is centigrade "°C"



The unit is Fahrenheit "°F"



### 8.15 RS485 communication baud rate

The RS485 communication baud rate can be modified according to actual needs.

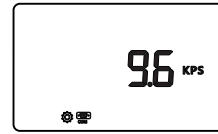

### 8.16 Equipment address

The device communication address can be modified according to actual needs.



### 8.17 System restart

Single press [ENTER], 'F01' flashes; single press [ENTER] again, the controller will reboot.



### 8.18 Factory reset

Reset the controller to factory default settings in accordance with "8.17".



### 8.19 Historical data cleaning

Clear the historical data of the controller in accordance with "8.17".



## 9. TTL communication

- 1) Default baud rate: 9,600 bps; check bit: none; data bit: 8 bit; stop bit: 1 bit
- 2) Communication power supply output specification: (8.5V±1V): 100mA

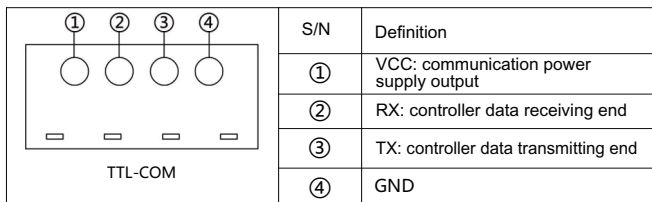

## 10. RS485

- 1) RS485 communication:  
Default baud rate: 9,600 bps; parity bit: none; data bit: 8 bit; stop bit: 1 bit  
Interface type: RJ45, communication power supply output specification: 5V/200mA
- 2) RJ45 interface communication line sequence definition:

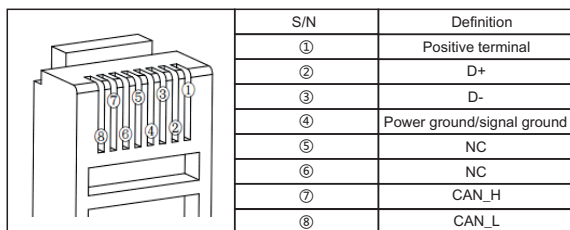

Note: NC represents an empty pin, which means that the pin is not connected.

## 11. CAN communication(Optional)

- 1) CAN communication: support RV-C protocol

## 12. Key

- [Select]: short press to switch browsing menu and set data increment;  
Press and hold the "System Alarm" interface for 2s to clear the "Load Short Circuit/Overload Protection" fault code.
- [Enter]: press and hold for 3s to enter/exit parameter setting;  
Short press: short press on/off load in menu browsing interface (manual mode);  
In the setting menu interface, short press for parameter modification and confirmation.

## 13. System alarms

System alarms	Meaning	Description
E0	Normal system	No action
E1	Battery over-discharge	Turn off load output, after the battery voltage rises to the over-discharge reconnect voltage, relieve over-discharge to restore load output
E2	Battery over-voltage	Stop charging, check and find out the cause of high battery voltage. The charging will be automatically restored after the battery voltage is lowered
E3	Battery under-voltage warning	Battery voltage below the under-voltage warning threshold, warning only
E4	Load short-circuited	Turn off load output
E5	Load over-current	Turn off load output, and perform delay protection by a multiple of rated current
E6	Over-temperature protection of device	When the internal temperature is higher than the set temperature, start the constant temperature control; Charging is prohibited when the temperature is higher than 75°C, and charging is resumed when the temperature is lower than 75°C.
E7	Battery over-temperature protection	Charging will be stopped when the battery temperature is above 65°C, and automatically resumed when it is below 60°C.
E10	Solar panel over-voltage	Charging is stopped, and then automatically resumed when the solar panel voltage is below the safety limit
E15	Lead acid battery is not connected	In lead-acid battery mode, the battery is damaged or not connected.
E16	Battery high temperature discharging protection	Load output will be turned off when the battery temperature is above 75°C and resumed when it is below 70°C.
E17	Battery low temperature discharging protection	Load output will be turned off when the battery temperature is below -35°C and resumed when it is above -30°C
E18	Overcharge protection	Charging is stopped and then resumed 10s after the battery voltage is lowered
E19	Battery low temperature charging protection	Charging will be stopped when the battery temperature is below -35°C and resumed when it is above -30°C
E30	Charging and discharging disabled by system setting	Off by default (set relevant registers by protocol)
E31	Charging overvoltage, overcurrent and reverse current protection etc.	After the abnormal conditions are removed, the equipment will recover automatically

## 14. Common problems and solutions

Phenomenon	Troubleshooting
LCD screen does not light up	Check whether the battery and solar panel are properly connected and whether the LCD connection cable has a poor connection
There is voltage in the solar panel, there is no voltage output from the battery side, and code E1/E15 is displayed	The battery is not detected at the lead-acid battery end, there is no voltage output from both ends of the battery. Connect the battery to return to normal or turn on the lead-acid battery activation switch
12V/24V/36V/48V normal voltage battery is connected, the battery icon on the LCD screen flashes slowly, and code E1 is displayed	Check the battery system voltage, or set it to automatically identify and reboot the controller
The system voltage 12V/24V/36V/48V icon on the screen flashes	Set system voltage change, prompting the user to reboot the system for the change to take effect
The controller fails to charge	Check whether there is wrong wiring, whether the solar panel voltage exceeds the rated value, whether the LCD screen displays any error code of internal over-temperature, external over-temperature, external lithium battery low temperature, or lead-acid battery open-circuit, and whether it displays E7/E10, etc.
Charging power does not reach the rated value	Perform system current limiting and thermostatic control; Check to see if the system has reset charging current
Other problems or exceptions difficult to resolve	Try to reboot (F01) or reset controller (F02), and reset relevant parameters again as per system configurations. Be careful
Fail to start some loads	Try enabling the load short-circuit function after checking that the wiring is correct
The screen displays "full", and charging stops	Charging stops as the charging cut-off current conditions are met. When the voltage is below the boost charging reconnect voltage, the charging will be automatically resumed
There is a system alarm code	See "12. System alarms" for details

## 15. Product Installation

### 15.1 Installation precautions

- ◆ Be careful when installing battery. Wear protective goggles when installing a flooded lead-acid battery. Once in contact with the battery acid, please rinse with water immediately.
- ◆ Keep away from metal objects to prevent short-circuit of battery.
- ◆ The battery may produce acid gas when charging. Make sure that the ambient environment is well-ventilated.
- ◆ The battery may produce combustible gas. Stay away from sparks.
- ◆ When installing outdoors, avoid direct sunlight and rain seeping.
- ◆ The falsely connected connection points and corroded wires may cause great heat, melt the wire insulation, burn the surrounding materials, and even cause fire. Therefore, it is necessary to ensure that all connectors are tightened, and the wires are preferably fixed with ties to avoid shaking of the wires during mobile applications loose connector.

- ◆ When connecting the system, the output voltage of the components may exceed the human body safety voltage, therefore, use insulated tools and keep your hands dry.
- ◆ The battery terminals on the controller can be connected either to a single battery or a battery pack. The subsequent instructions are for a single battery, but they are also applicable to systems with a battery pack.
- ◆ Please follow the safety recommendations of the battery manufacturer.
- ◆ The system connection cables selected shall have a current density  $\leq 4A/mm^2$ .
- ◆ Ground the ground terminal of the controller.
- ◆ When installing the battery, it is forbidden to reverse the battery connection, which may cause irreversible damage.

### 15.2 Installation steps

Wiring and installation must meet the requirements of national and local electrical codes. Wiring specifications shall be selected according to the rated current, generally,  $5 A/mm^2$ .

#### Step 1: Select an installation location

Do not install the controller in a place with direct sunlight, high temperature, or where water can easily enter, and make sure the controller is well ventilated.

#### Step 2: Fix suspension screws

Mark the mounting position according to the mounting dimensions of the controller, drill two mounting holes of suitable size at the two marks and fix the screws on the two mounting holes.

#### Step 3: Fix the controller

Align the controller fixing holes with the two pre-fixed screws to hang the controller up, and then fix the two screws below.

#### Step 4: Open the front cover of the controller, wire, and then close the front cover.

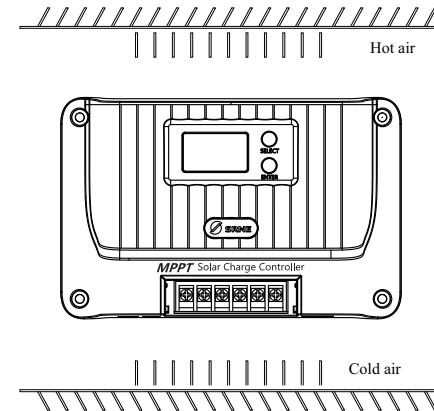

## 16. Protection Functions

- ◆ Over-temperature protection of device  
When the internal temperature of the controller exceeds the set value, the charging power will be automatically lowered or the charging will even be stopped, further slowing the rise in internal temperature of the controller.
- ◆ Battery over-temperature protection  
Battery over-temperature protection requires an external battery temperature sampling sensor. Charging will be stopped when the battery temperature is detected to be too high, and will be automatically resumed when the battery temperature drops to 5°C below the set value for 2s.
- ◆ Input over-power protection  
When the battery panel power is greater than the rated power, the controller will limit the charging power within the rated power range to prevent excessive current from damaging to the controller, and the controller will enter current-limited charging.
- ◆ PV input side too high voltage protection  
When the voltage at the input side of the PV array is too high, the controller will automatically cut off PV input.
- ◆ PV input reverse-connection protection  
The controller will not be damaged if the polarity of the PV array is reversed and will return to normal after the wiring error is corrected.
- ◆ Reverse charging protection at night  
Prevent the battery from discharging through solar battery at night.

## 17. System Maintenance

In order to maintain the optimal operating performance of the controller for a long time, it is recommended that the following items are regularly checked.

- ◆ Make sure that the airflow around the controller is not blocked, and remove any dirt or debris from the radiator.
- ◆ Take corrective actions timely after any fault or error is found.
- ◆ Check whether there is corrosion, insulation damage, high temperature or burning/discoloring at terminals, case distortion, etc., and repair or replace timely if any.
- ◆ Check whether there is any exposed or broken wire or wire with poor insulation, and repair or replace timely if any.
- ◆ Check whether there is dirt, nesting insects or corrosion, and clean timely if any.

**Warning: There is a risk of electrical shock! Before carrying out checks or operations above, make sure that all power supplies for the controller are disconnected!**

**Any non-professional personnel is prohibited from carrying out such operations.**

## 18. Product Dimensions

### 18.1 Shiner2410

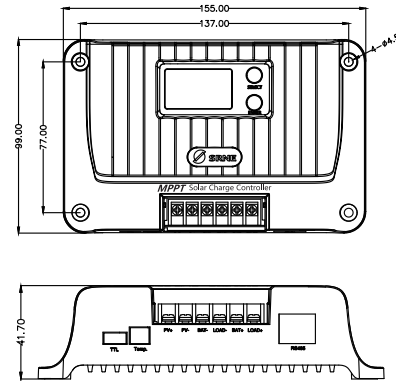

Model: Shiner2410  
Product dimension: 155\*99\*41.7mm  
Mounting hole spacing: 137\*77mm  
Fixed hole position:  $\phi$ 4.5mm

### 18.2 Shiner2420/Shiner4820

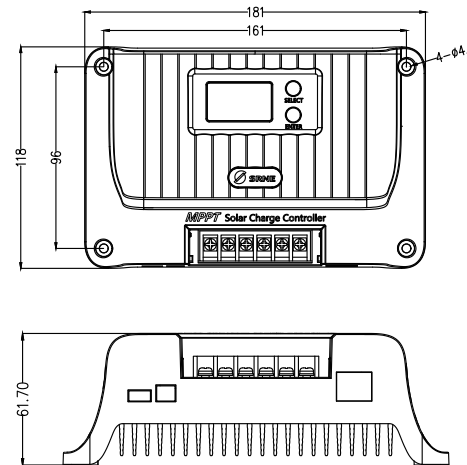

Model: Shiner2420/Shiner4820  
Product dimension: 181\*118\*61.7mm  
Mounting hole spacing: 161\*96mm  
Fixed hole position:  $\phi$ 4.5mm

### 18.3 Shiner2430

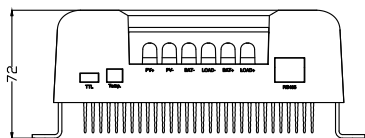
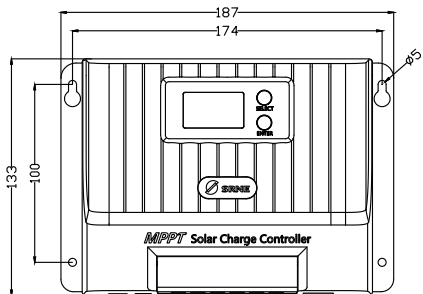

Model: Shiner2430  
 Product dimension: 187\*133\*72mm  
 Mounting hole spacing: 174\*100mm  
 Fixed hole position: φ5mm

### 18.4 Shiner2440

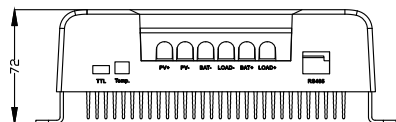
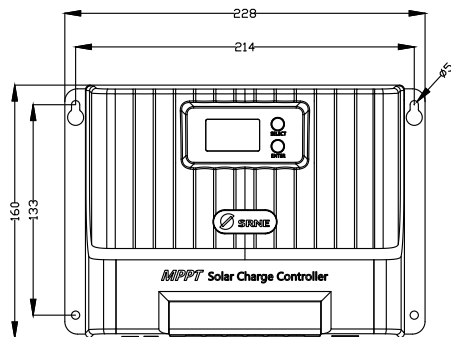

Model: Shiner2440  
 Product dimension: 228\*160\*72mm  
 Mounting hole spacing: 214\*133mm  
 Fixed hole position: φ5mm

### 18.5 Shiner2460

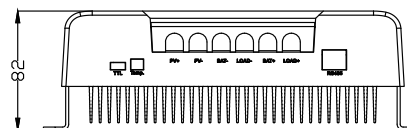
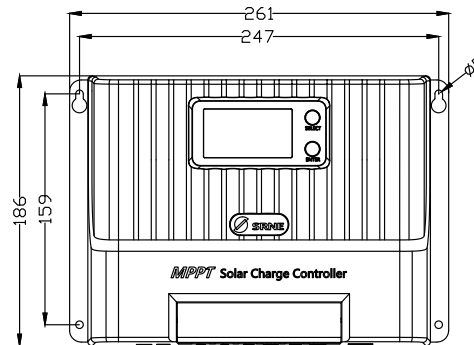

Model: Shiner2460  
 Product dimension: 261\*186\*82mm  
 Mounting hole spacing: 247\*159mm  
 Fixed hole position: φ5mm

## 18. System wiring diagram

### 18.1 System wiring diagram

